



2SC2578

NPN PLANAR SILICON TRANSISTOR

AUDIO POWER AMPLIFIER DC TO DC CONVERTER

- High Current Capability
- High Power Dissipation
- Complementary to 2SA1104

ABSOLUTE MAXIMUM RATING (T_A=25°C)

Characteristic	Symbol	Rating	Unit
Collector-Base Voltage	V _{CB0}	140	V
Collector-Emitter Voltage	V _{CE0}	100	V
Emitter-Base voltage	V _{EB0}	6	V
Collector Current (DC)	I _C	7	A
Collector Dissipation	P _C	70	W
Junction Temperature	T _j	150	°C
Storage Temperature	T _{stg}	-55~150	°C

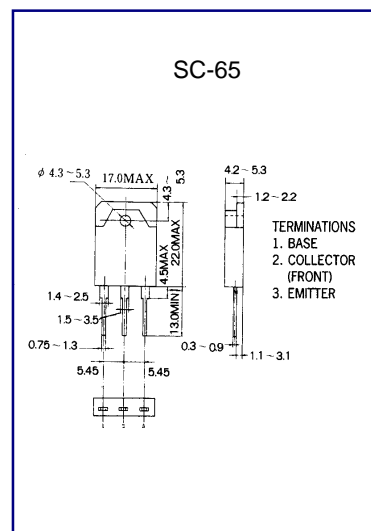

ELECTRICAL CHARACTERISTICS (T_A=25°C)

Characteristic	Symbol	Test Condition	Min	Typ	Max	Unit
Collector Base Breakdown Voltage	BV _{CB0}	I _C =5 mA I _E =0	140			V
Collector Emitter Breakdown Voltage	BV _{CE0}	I _C =10 mA R _{BE} =∞	100			V
Emitter Base Breakdown Voltage	BV _{EB0}	I _E =5 mA I _C =0	6			V
Collector Cutoff Current	I _{CB0}	V _{CB} =100V I _E =0			0.1	mA
Emitter Cutoff Current	I _{EB0}	V _{EB} =4V I _C =0			0.1	mA
*DC Current Gain	h _{FE1}	V _{CE} =5V I _C =1A	55		160	
DC Current Gain	h _{FE2}	V _{CE} =5V I _C =3A	50			
Collector- Emitter Saturation Voltage	V _{CE(sat)}	I _C =3A I _B =0.3A			2.0	V